

**SURFACE MOUNT  
SCHOTTKY BARRIER RECTIFIER**

**REVERSE VOLTAGE – 40 Volts  
FORWARD CURRENT – 1.0 Ampere**

**FEATURES**

- Low Forward Voltage Drop
- High Surge Capability and High Current Capability
- For Surface Mounted Applications
- High Conductance
- Guard Ring Construction for Transient Protection
- ESD Capability:  
Machine Model, C (> 400 V)  
Human Body Model, 3B (> 8 kV)
- IEC 61000-4-2, level 4 (ESD), >15KV (air)

**MECHANICAL DATA**

- Case: SOD-123 Plastic
- Case Material: "Green" molding compound, UL flammability classification 94V-0, (No Br. Sb. Cl)
- Moisture Sensitivity: Level 1 per J-STD-020D
- Lead Pb-Free in RoHS 2002/95/EC Compliant
- Weight: approx. 0.01 grams (approximate)

**SOD-123**

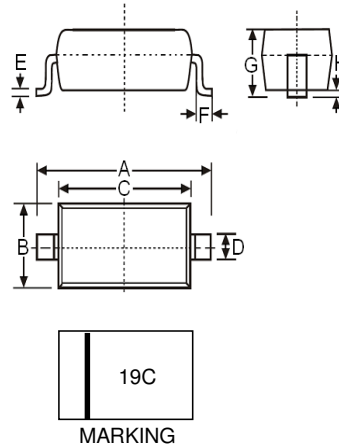

SOD-123		
Dim.	Min.	Max.
A	3.55	3.85
B	1.40	1.70
C	2.55	2.85
D	0.55 Typical	
E	0.11 Typical	
F	0.25	---
G	---	1.35
H	---	0.10
All Dimensions in millimeter		

**MAXIMUM RATINGS AND ELECTRICAL CHARACTERISTICS**

Ratings at 25°C ambient temperature unless otherwise specified.

**ABSOLUTE RATINGS**

PARAMETER	SYMBOL	VALUE	UNIT
Repetitive peak reverse voltage	$V_{RRM}$	40	V
Working peak reverse voltage	$V_{RWM}$		
DC blocking voltage	$V_R$		
Forward continuous current (Note 1)	$I_F$	1.0	A
Non-Repetitive Peak Forward Surge Current 8.3ms Single half sine-wave superimposed on rated load(JEDEC Method)	$I_{FSM}$	25	A
Power dissipation (Note 1)	$P_D$	450	mW
Thermal Resistance (Note 2)	$R_{\theta JA}$	230	°C/W
Operation and storage temperature range	$T_J, T_{STG}$	-65 to +125	°C

**ELECTRICAL CHARACTERISTICS**

PARAMETER	TEST CONDITION	SYMBOL	MAX	UNIT
Minimum Reverse Breakdown Voltage	$I_R = 1.0mA$	$V_{(BR)R}$	40	V
Maximum Forward Voltage	$I_F = 0.1A$	$V_F$	320	mV
	$I_F = 1.0A$		450	
	$I_F = 3.0A$		750	
Maximum DC Reverse Current at Rated DC Blocking Voltage	$V_R = 4.0V, T_J = 25^\circ C$	$I_R$	50	uA
	$V_R = 6.0V, T_J = 25^\circ C$		75	
	$V_R = 40V, T_J = 25^\circ C$		1.0	mA
	$V_R = 40V, T_J = 100^\circ C$		10	
	$V_R = 4.0V, T_J = 100^\circ C$		2.0	
Typical Junction Capacitance (Note 1)	$V_R = 4V DC, f = 1.0MHz$	$C_J$	3.0	pF
			70	

**Note :**

- (1) Unit mounted with 7.0\*7.0mm copper pad areas
- (2) Thermal Resistance Junction to Ambient,

REV. 1, Mar.-2016, KSYR82

**FIG.1- FORWARD CURRENT DERATING CURVE**

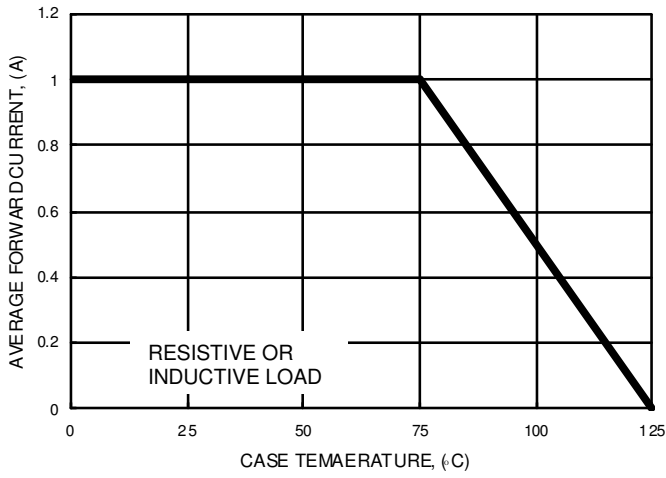

**FIG.2- TYPICAL JUNCTION CAPACITANCE**

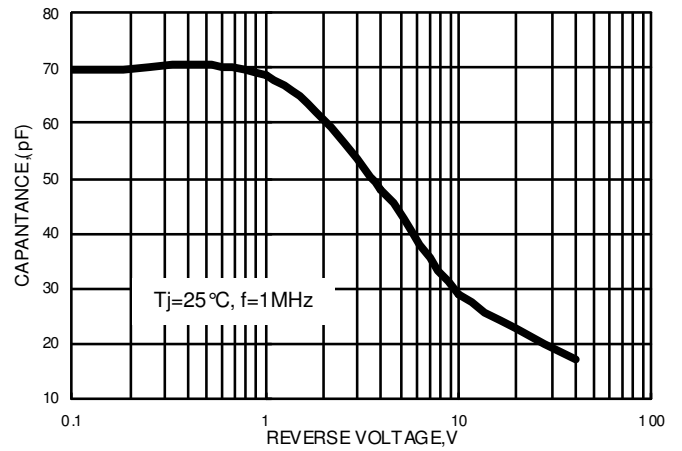

**FIG.3- TYPICAL FORWARD CHARACTERISTICS**

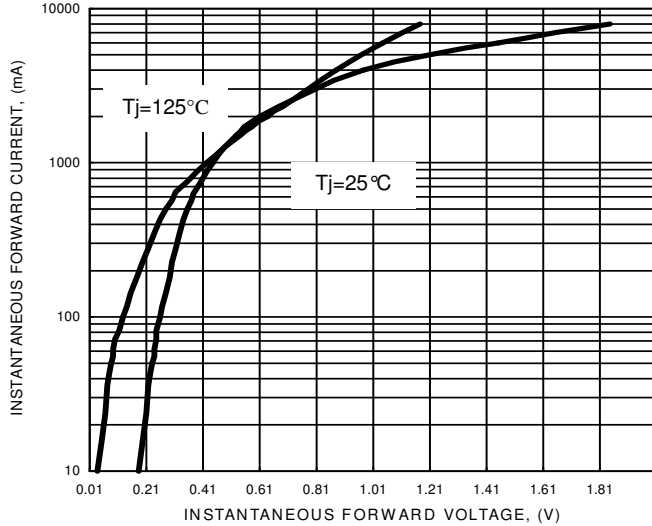

**FIG.4- TYPICAL REVERSE CHARACTERISTICS**

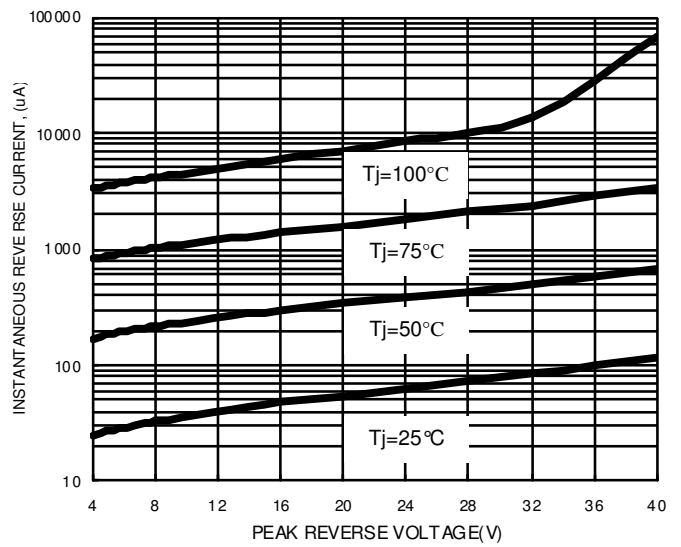

**FIG.5- MAXIMUM NON-REPETITIVE SURGE CURRENT**

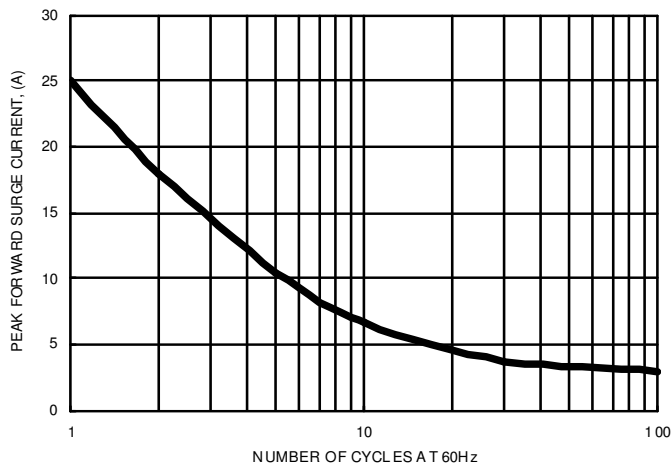

**FIG.6- DC REVERSE VOLTAGE DERATING CURVE**

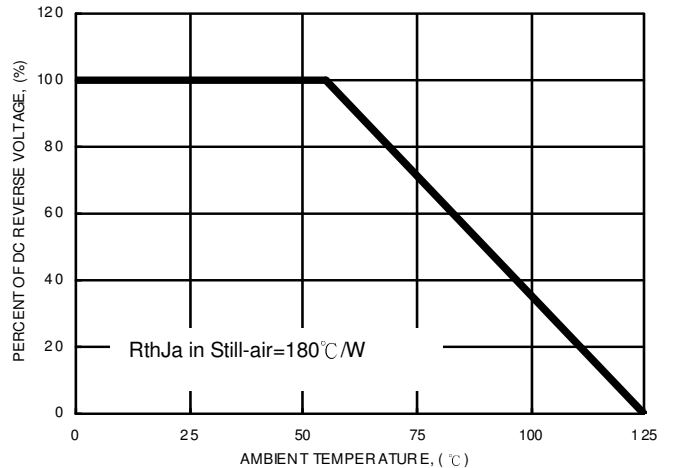

## **Important Notice and Disclaimer**

LSC reserves the right to make changes to this document and its products and specifications at any time without notice. Customers should obtain and confirm the latest product information and specifications before final design, purchase or use.

LSC makes no warranty, representation or guarantee regarding the suitability of its products for any particular purpose, nor does LSC assume any liability for application assistance or customer product design. LSC does not warrant or accept any liability with products which are purchased or used for any unintended or unauthorized application.

No license is granted by implication or otherwise under any intellectual property rights of LSC.

LSC products are not authorized for use as critical components in life support devices or systems without express written approval of LSC.